

Metals 2 Go



JANUS *[International]*

superior product + recognized value

1950
commercial



JANUS[®]

[International]

The value engineered model 1950 is the first of the next generation of rolling sheet doors to feature a substantial economical advantage. By elevating industry standards, to maintaining the highest quality and value, this door features innovative components that make the Model 1950 more versatile, flexible and easier to install and service in a variety of field applications.

FEATURES

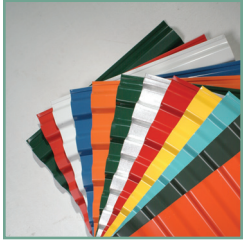

The 26 gauge corrugated door curtain is manufactured from full hard galvanized grade 80 steel and coated with Super Durable polyester paint that is backed by a 40 year film integrity and 25 year no-fade limited paint warranty. Available in sizes up to 12'0" x 14'0" and in over 20 different standard colors.

Tough, durable and wide, heavy duty nylon strapping helps control curtain stretch and works in conjunction with the vinyl guide strip to reduce wear and deaden sound.

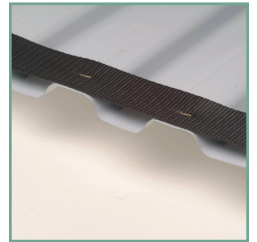

The slide bolt lock assembly affixed to the bottom bar at each end of the door curtain fastens through the guide to securely keep the door locked and in the down position. Padlocks can be attached to the slide to further secure the door.

The flat door stop slide makes installation quicker. Simply slide through the hub through the slot on the guide and affix with a fastener.



9-1/2" diameter drums allow for lower headroom requirements. An enclosed barrel houses the dead axle assembly and protects the factory lubricated springs from direct contact with environmental elements. The inherent strength provided by the spiral barrel minimizes axle deflection, providing smoother operation. Because the curtain is attached by screws and not seamed to the barrel, replacement of either independent assembly is cost-effective, quick and easy.

Grease-filled, shielded radial ball bearings at the drums provide longevity and smooth operation. Factory installed insert nuts help make the installation of the chain hoist and operator sprocket easier.

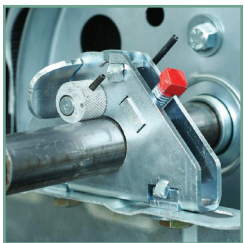

A cam-action spring tension holding device allows quick, easy and equal adjustment of the tension on all springs simultaneously from one end of the door. The cam tensioner bites into the axle helping to eliminate the unwanted spinning of the axle during the initial spring loading or adjustment process.



A reduced drive chain hoist allows for smoother operation on doors over 10'0" wide or 10'0" tall.

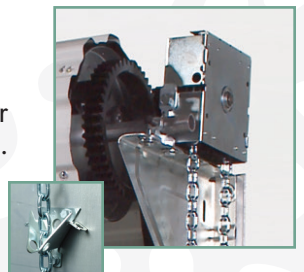

superior product + recognized value

Three manufacturing facilities located throughout the United States and a team of experienced door experts are available to assist you with any of your door needs.

1950

commercial

One year warranty on workmanship and material.

Mounting brackets are engineered and designed with deep embossing for strength, and are independently tested to withstand more than 1,200 pounds per pair. The installation-friendly mounting brackets feature safe rounded edges and slots that allow for easy vertical adjustments as well as various installation preferences.

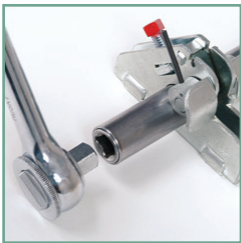

Convenient spring tension adjustment is accommodated by inserting a common 3/8" ratchet tool into the end of the drive shaft and rotating. Initial loading of the door tension can be easily accomplished with a ratchet without the difficulty of spinning the door. This innovation also allows the tension to be easily measured and managed with a torque wrench.

OPTIONS

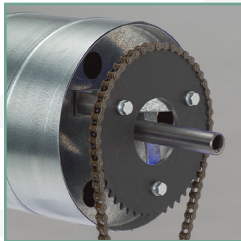

The electrical operation kit includes a sprocket and torque struts that equip the door for wall mounted jackshaft electric operators and can be furnished in lieu of reduced drive chain hoist when provided.

Insulation is made of a foil backed, dual layer of heavy-duty polyethylene air-bubble insulation secured in place with a strong adhesive and joined by mylar film. (Top draft stop and side draft stops are also included.)

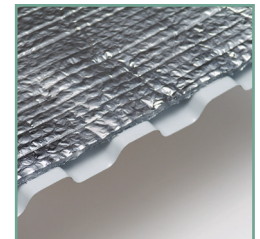

The header seal attaches directly to the header and extends up to 5" to the door curtain to form an effective barrier from environmental elements.

Top draft stop mounted to the door curtain provides a 2-1/4" weather seal between the door and the header.

GUIDE DETAILS

Universal mount 2.5" deep 16 gauge galvanized steel guides require no pre-installation modifications for wood, steel, concrete or masonry block applications.

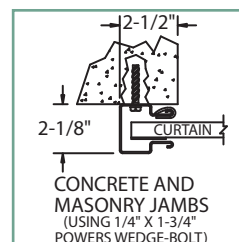
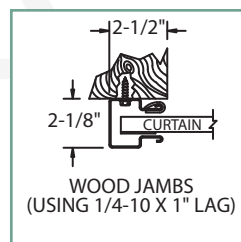
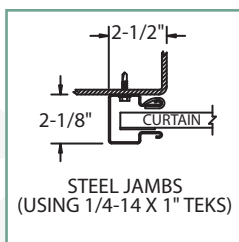

Side Room Requirements

Operation	Guide	Outside of Bracket Tensioner End	Outside of Hand Chain Drive	Outside of Bracket Drive End	Each End of Axle
Push Up	2-1/2"	4-1/8"	N/A	4-1/8"	7"
Reduced Drive Chain	2-1/2"	4-1/8"	7"	5-1/2"	7"
Electric	2-1/2"	4-1/8"	N/A	5-5/8"	7"

IMPORTANT NOTES:

- Dimensions are referenced from edge of opening.
- Tensioner end and drive end can be installed at either end of door assembly.
- FOR CRITICAL FITS DUE TO REDUCED AVAILABLE HEADROOM or SIDEROOM CLEARANCES < CONSULT FACTORY.

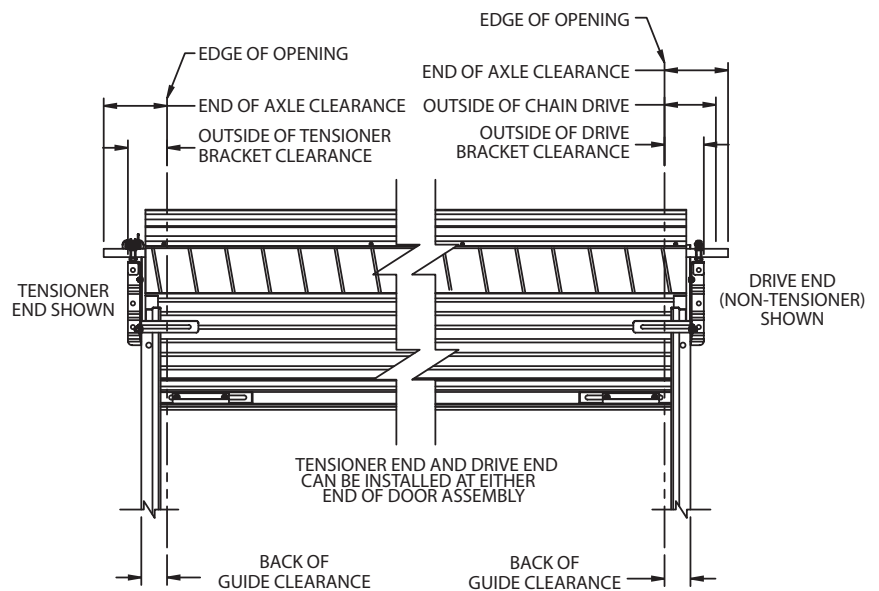
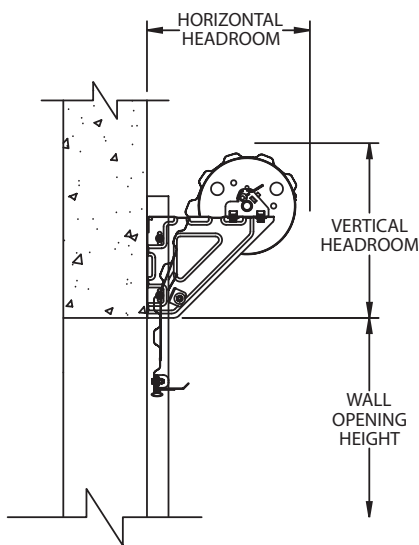

Head Room Requirements

Opening Height	Vertical Headroom	Horizontal Headroom
Thru 8'0"	19"	19"
Over 8'0" thru 10'0"	20"	20"
Over 10'0" thru 14'0"	20 1/2"	20"